

## Skyfall Block of the Month #34



**Block Size 5½" x 5½"**

The **Corner Beam** tool and the **V Block** tool are required for this block. These tools are available at my online store at [www.KathieBeltz.com](http://www.KathieBeltz.com) or at your local quilt shop.

### Cutting Instructions:

- From Red Fabric:
  - Cut 1 strip 2" x 6"
  - Cut 4 squares 2" x 2"
  - Cut 1 strip 1½" x 3½"
  - Cut 2 squares 1½" x 1½"
- From Dark Blue Fabric (Background):
  - Cut 2 strips 2" x 12½"
  - Cut 4 rectangles 1½" x 2½"
  - Cut 4 squares 1½" x 1½"

### Construction:

#### Cutting the Center Beam:

- Stack the four 2" squares of the Red Fabric right sides up. Find the dashed line on the Center Beam tool labeled *Center Beam Trim #1*. Position that dashed line against the left edge of the stack of squares, **while at the same time position the first line of the tool with the bottom edge of the square** (marked 1" Finished Unit/Cut Strips & Squares 2"). Trim along the slanted edge of the tool.

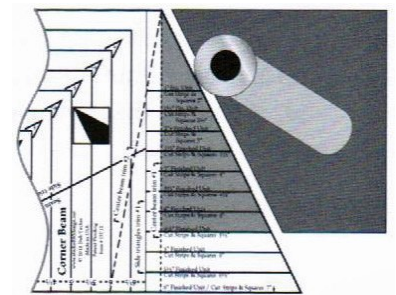

- Locate the dashed/dotted line labeled *Center Beam Trim #2*. Carefully lift and reposition the tool, placing the dashed/dotted line on the raw edge you just trimmed, matching up the two diagonals at the tip. Trim again along the slanted edge of the tool. The resulting kite shape will be the center of your Corner Beam unit.

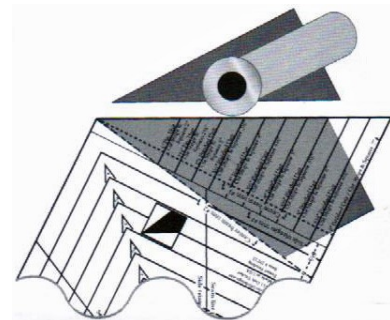

Note: There will also be waste triangles from this cut that will be mirror images of the first-cut triangles.

- Set aside the trimmed triangles, and save the kite shaped units for the later Corner Beam construction.

### Cutting the Side Triangles:

- Using one 2" x 12½" strip of Dark Blue Fabric, fold the strip either right sides together or wrong sides together to get the mirror image pairs that you'll need for Corner Beam construction.

- Locate the solid thick line labeled *Side triangles trim #1* on the tool. Position this thick line on the trimmed end of the folded strip, **while at the same time position the first line of the tool with the bottom edge of the square** (marked 1" Finished Unit/Cut Strips & Squares 2"). Trim along the slanted edge of the tool to create the first pair of triangle shapes.

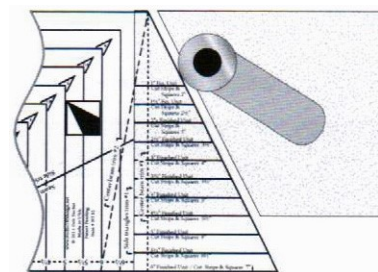

- Rotate the tool one quarter turn counterclockwise.
- Locate the line labeled *Side triangles trim #2*. This is a shared line with one of the Seam line placement lines for the sewn unit. Then locate the short, thick line near the square corner of the tool that is labeled *Second trim*. Position that line at the bottom edge of the strip, and the *Side triangles trim #2* line along the left edge of the strip that you just trimmed. Make your second cut along the straight, longest edge of the tool. This will create the second pair of triangle shapes.

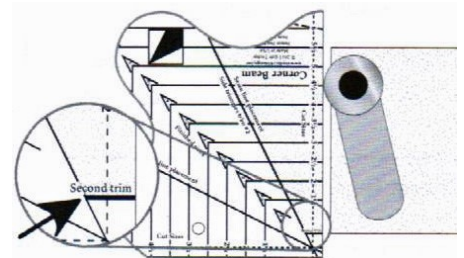

- Rotate the tool back one quarter turn clockwise, line up the *Side triangles trim #1* line on the straight, left edge, and repeat the cut along the slanted edge as before. Continue cutting, rotating, and positioning until you have 4 pairs of side triangles.

## Block Construction:

- Lay out the Red kite shaped pieces and Dark Blue side triangles, all right sides up, as positioned in the diagram. Double check that the pieces are properly positioned before sewing.

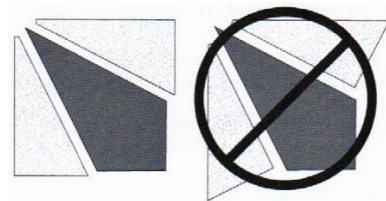

- Starting with a kite shape and one side triangle, line up the pieces right sides together and raw edges even so that the triangle piece is slightly shifted down from the sharp tip of the kite piece (see diagram). Stitch into place, starting from the wide end toward the tip. Press toward the side triangle, then add the other side triangle in the same fashion.

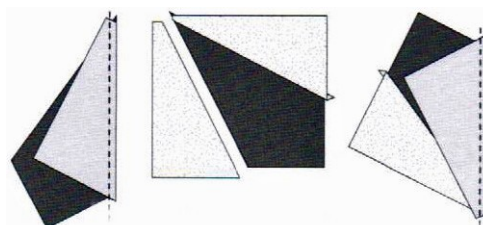

Note: Be careful that the seam does not skew at the tip. Make sure to press the first seam before adding the second triangle.

- The completed blocks will finish slightly oversized and will need to be trimmed down. For trimming, position the pointy end of the block in the upper right hand corner. Carefully line up the two diagonal *Seam line placement* guidelines directly on top of the sewn seam lines. It is important that you pay close attention to the point where the seam lines cross. Careful alignment here will give you the crisp points in this block. Trim up the right side, then from right to left across the top to square the first corner.

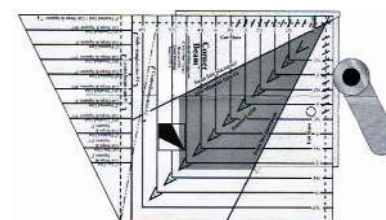

- Rotate the block 180 degrees. The corner you just trimmed will now be on the lower left side. Locate the lines for the 1 1/2" square on the tool, and place the square guidelines on top of the two edges you just trimmed. The V-shaped guide should line up with the sharp tip of the pieced unit. Trim up the right side, then from right to left across the top to square the second corner.

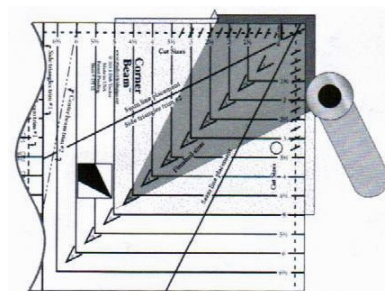

## Construction: V Blocks

- Following the instructions that came with your V Block tool, cut 4 Center Triangles from the 2" x 6" Red strip.
- Following the instructions that came with your V Block tool, cut 8 Side Triangles from the 2" x 12½" Dark Blue strip.
- Lay out the Center Triangles and Side Triangles face up as shown. Make sure that the Side Triangles are in the correct orientation.

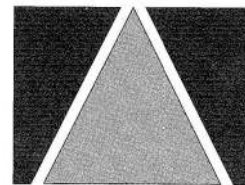

- Position a Dark Blue Side Triangle and a Red Center Triangle right sides together, lining up the slanted cut edges. Line up the pieces “tip to tip.” Stitch with a 1/4" seam. (See diagram below.)
- Press the seam toward the Dark Blue triangle.
- Position the other Dark Blue Side Triangle and the Red Center Triangle right sides together, lining up the slanted cut edges. Line up the pieces “tip to tip.” Stitch with a 1/4" seam. (See diagram below.)
- Press the seam toward the Dark Blue triangle.

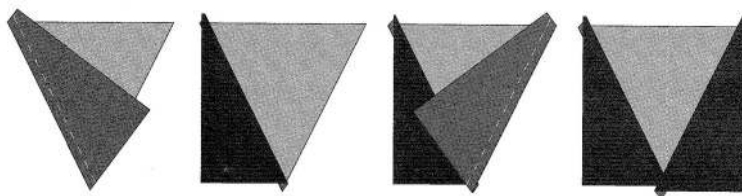

- Repeat to make 4 blocks total.
- These four V Blocks units need to be trimmed down to 1 ½" square. Following the trimming instructions included with the V Block tool, position the block with the point of the “V” facing you. Align the sewn seams of the block with the topmost right set of “V” lines on the V Block tool. (Note: you’ll see the Number 1 near the bottom of the diagonal line.) Make sure there is fabric beyond the 1 ½" lines of the square. Trim two sides.
- Rotate the block. Align the 1 ½" square lines with the two sides you just trimmed, and line up the “X” with the tip of the “V.” Trim the other two sides.
- Repeat to trim all four blocks.

- Lay out the four Corner Beam units, the four V Block units, and the remaining rectangles and squares as shown in the diagram.

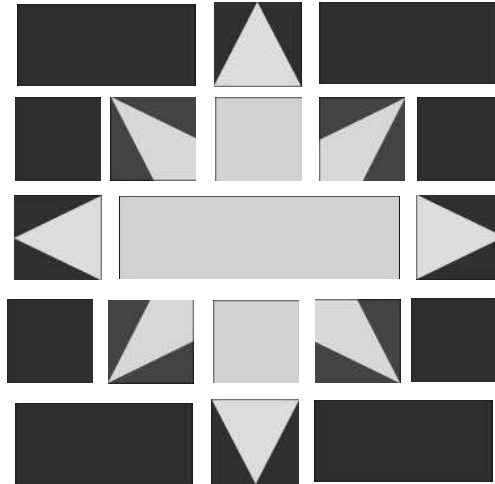

- Sew the two rectangles and one V Block unit together in the top and bottom rows - press seams open.
- Sew the two squares, the two Corner Beam units, and the Red square together in the second and fourth rows - press seams open.
- Sew the two V Block units and the Red strip together in the center row - Press seams open.
- Sew the five rows together, matching the seams - press seams open to complete block.

© 2022 Kathie Beltz Quilt Designs



**Kathie Beltz**

Quilter ~ Teacher ~ Judge  
Studio 180 Design Certified Instructor

Contact me at [Kathie@KathieBeltz.com](mailto:Kathie@KathieBeltz.com)  
Check out my website at [www.KathieBeltz.com](http://www.KathieBeltz.com)  
Facebook/[KathieBeltzQuilter](https://www.facebook.com/KathieBeltzQuilter)  
Instagram/[kathiebeltz](https://www.instagram.com/kathiebeltz)  
Pinterest/[KBQDesigns](https://www.pinterest.com/KBQDesigns)